

XP-PEN[®]

User Manual

Artist Pro 16 Pen Display

Contents

I Overview

1.1 Product Overview

1.2 Accessories

1.3 Connection

II Get started with your pen display

2.1 Download

2.2 Installation

2.3 Introduction to Driver

2.4 Work Area

2.5 Application

2.6 Pen Settings

2.7 Shortcut Keys

2.8 Touch/Roller

2.9 Settings

I Overview

1.1 Product Overview

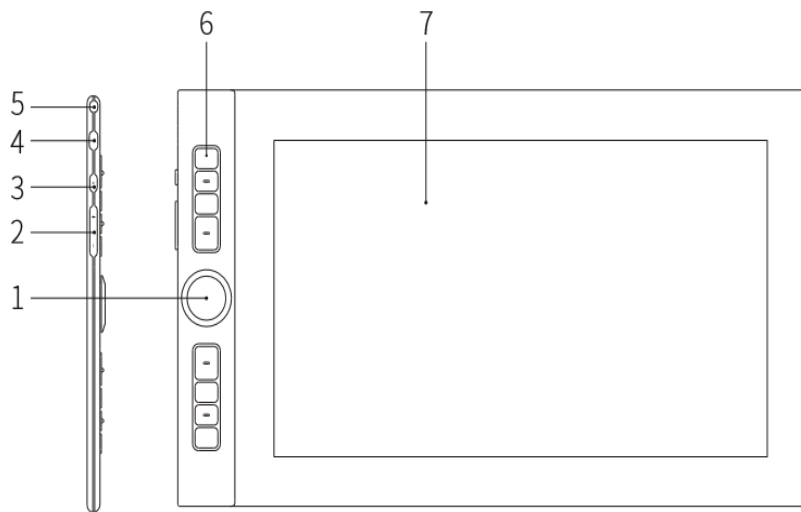

1. Roller
2. Brightness up/down
3. Power key
4. USB-C port
5. Security slot
6. Shortcut key
7. Display/Working area

1.2 Accessories

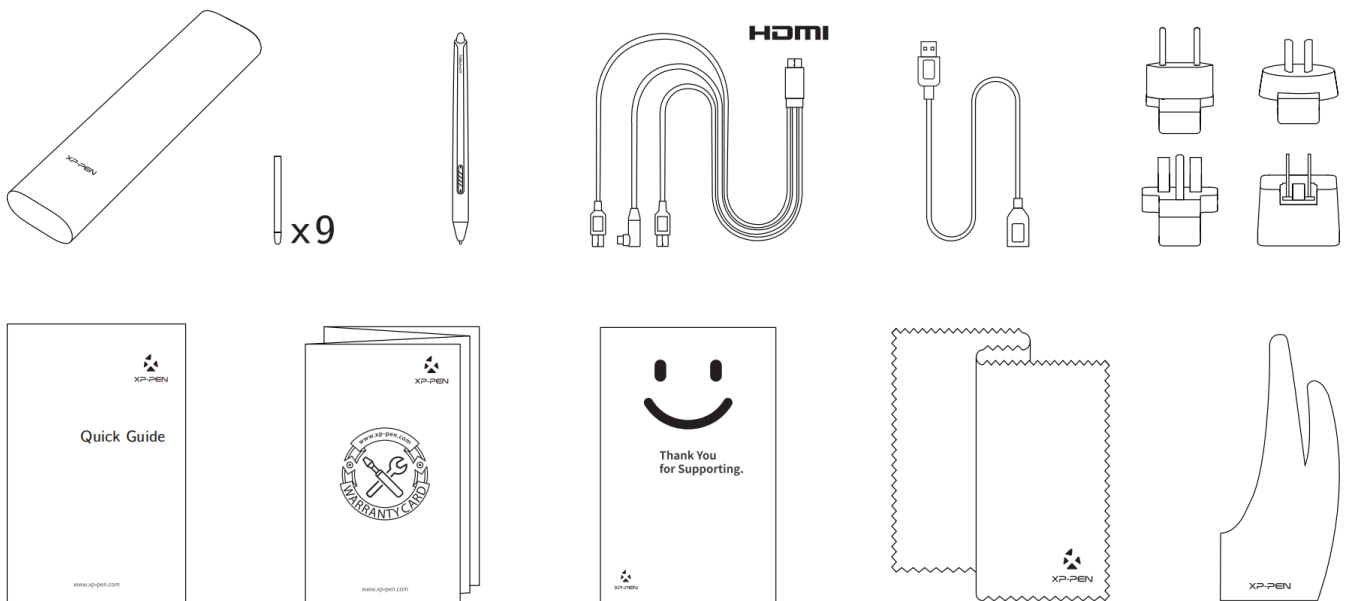

*The terms HDMI and HDMI High-Definition Multimedia Interface, and the HDMI Logo are trademarks or registered trademarks of HDMI Licensing Administrator, Inc. in the United States and other countries.

1.3 Connection

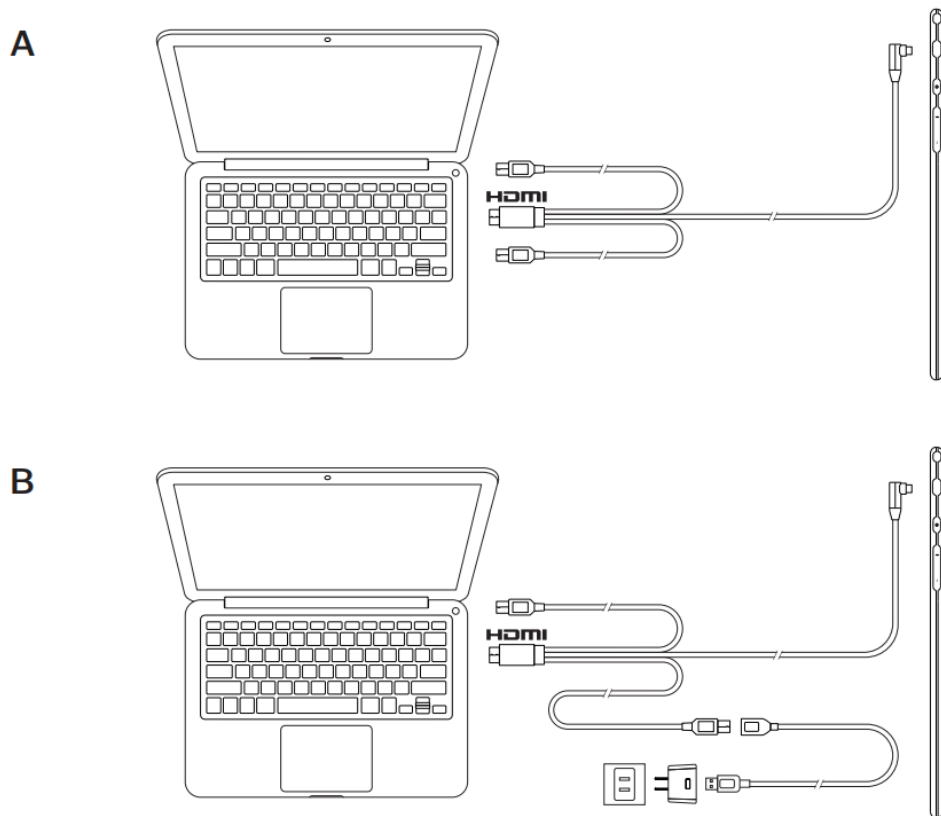

II Get started with your pen display

2.1 Download

Please download the corresponding driver according to your product model from the XP-PEN official website (<https://www.xp-pen.com>).

2.2 Installation

After downloading is completed, please unzip the folder and operate the ".exe" file (Windows) or ".dmg" (Mac) file, and then follow the prompts until installation is completed.

Notes:

1. Before installation, please temporarily close the antivirus software and firewall, and all opened software.
2. If other drivers have been installed on the computer, please uninstall them first.
3. It is recommended to restart the computer after installation is completed.
4. For the best performance of your device, we highly recommend you check and update the driver regularly from XP-PEN website.

2.3 Introduction to Driver

After the driver is installed, connect your device to your computer, and then open the driver to start customizing your device.

Notes:

This document describes all the functions of the driver, but the functions in the actual use process will vary due to different connected devices. Please refer to the device you actually used for specific functions.

Store configuration:

If you need to make the changed configuration still valid when you use it next time after exiting the driver, please click the "OK" button on the left side of the driver interface to save the settings after changing the configuration. If the settings are successfully saved, the prompt "Configuration saved successfully" will be given; otherwise, the changed configuration will be valid only when it is currently used.

2.4 Work area

2.4.1 Screen

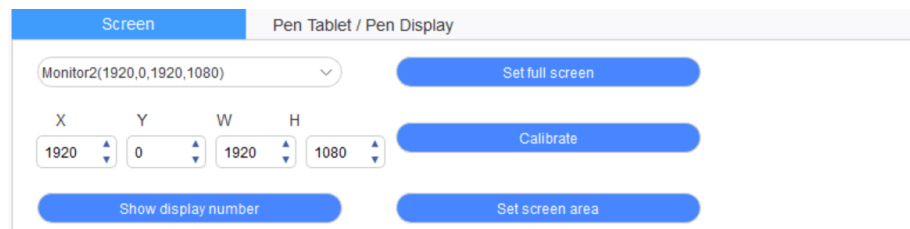

If multiple monitors are used in duplicate mode (i.e. All monitors display the same picture), the work area of the device will be mapped to all monitors. When the pen moves in the work area, the cursor on all monitors will move at the same time.

If multiple monitors are used in extended mode, it is necessary to select the work area of the device on the driver interface to map to the corresponding monitor.

The driver provides three modes to set the display area of the screen:

- (1) Set full screen: Set the screen area of the selected monitor to the maximum.
- (2) Set screen area: Use the mouse to manually set the display area of the screen. Click the first position (top left) of the display area of the screen with the mouse, and then click the second position (bottom right).
- (3) Customize: Manually enter coordinates in the corresponding input boxes below X, Y, W, and H to customize the size of the display area of the screen, or use the mouse to drag on the screen icon of the driver interface to adjust the display area of the screen.

Calibration:

Calibrate the offset between the stylus and the cursor.

Show display number:

Identify all connected monitors, and numeric identifiers will be displayed in the lower-left corner of each monitor.

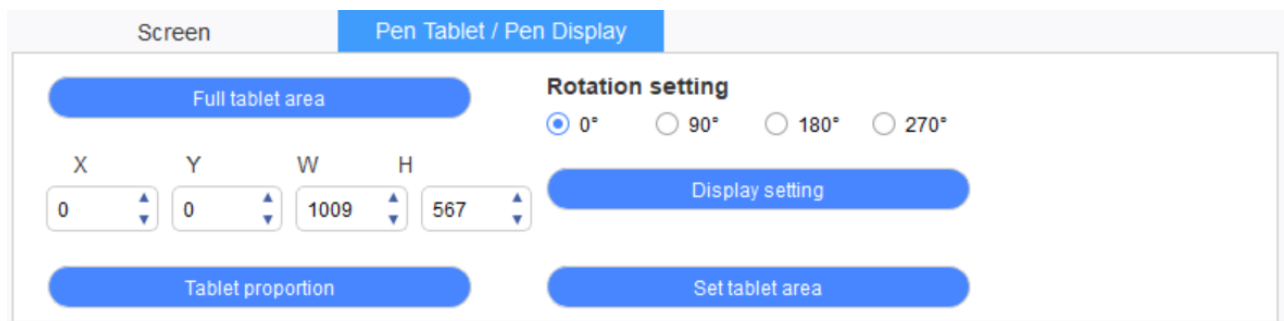
2.4.2 Pen Tablet/Pen Display

Set any part of the work area of the device to be mapped as the display area of the screen. The driver provides four modes for selection:

- (1) Full tablet area: Maximize the work area of the device.
- (2) Tablet proportion: Scale the work area of the device and your screen in equal proportions.
- (3) Set tablet area: Use a stylus to click the positions of "top left corner" and "bottom right corner" to be selected.
- (4) Customize: Manually enter coordinates in the corresponding input boxes below X, Y, W, and H to determine the size of the work area of the device, or use the stylus to drag on the device icon on the driver interface to set the size of the work area.

Rotation setting:

You may set the device to 0°, 90°, 180° & 270°. After finishing the setting, you also need to rotate the device to the corresponding direction.

Display setting:

Set the "color temperature ", "brightness" and "contrast" of the pen display.

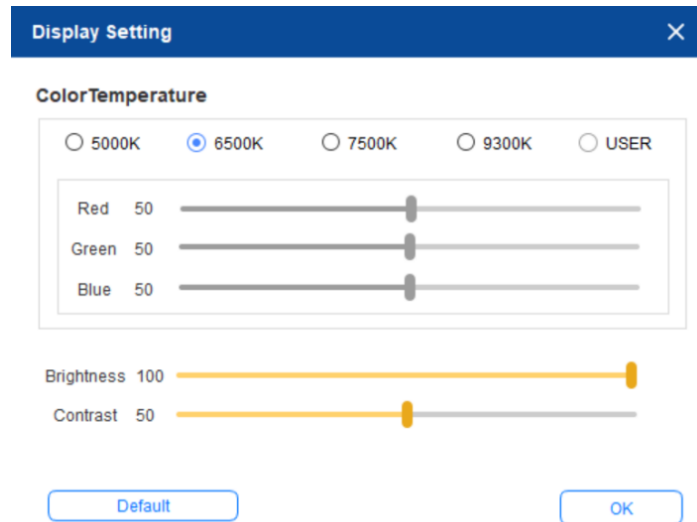

2.5 Application

After selecting the application, set the function you want for this application.

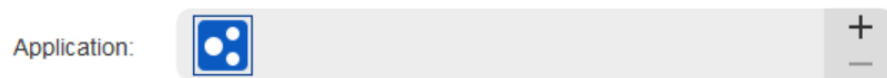

- Click the "+" on the top right of the application bar to open the application selection interface.
- Select application to be added from the running program or click the "browse" button to add from the installed software; after the application is selected, the path of the selected application will be displayed at the bottom.

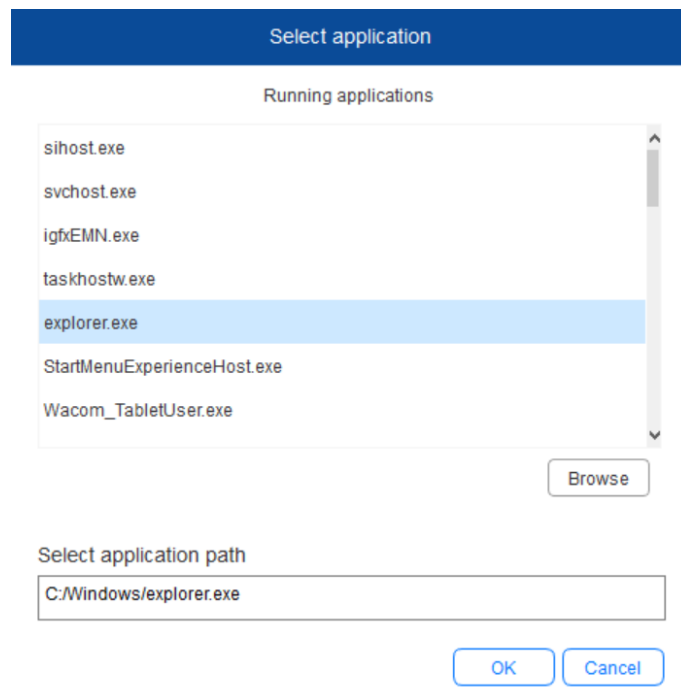

- Click the "OK" button at the bottom of the interface, and the application just selected will be added to the application bar.

2.6 Pen settings

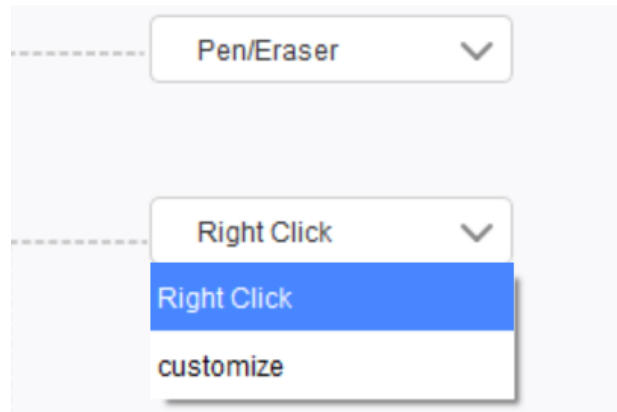

Pen keys:

Set functions of the pen keys here. You may click the drop-down menu to use "Customize" to do so.

Notes:

When the pen is within the working range of the device, single-click the key to switch the pen or eraser mode. When other functions are switched, the current switching mode will be displayed at the bottom of your screen.

Selecting "Use mouse control" and "input from keyboard" in the "customize" function allows you to customize functions of the combination key.

Use mouse control:

You may configure mouse controls and keyboard keys here. With the "Keyboard Shift" and "Left Click" selected, shortcut actions are enabled in software that supports such combination keys.

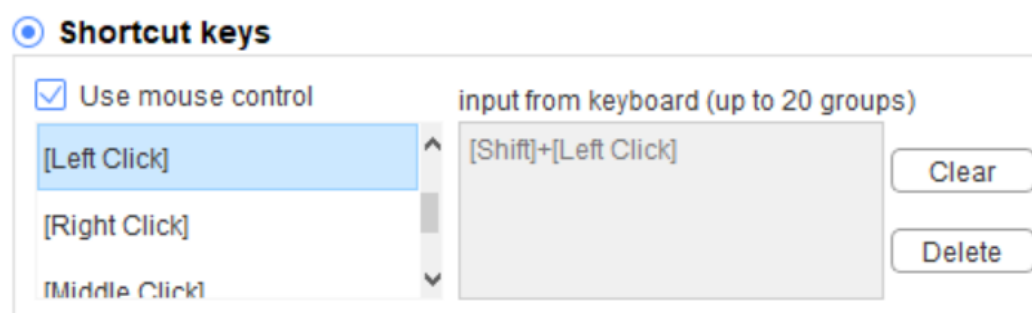

Input from the keyboard:

You may configure keyboard shortcuts here, for example, set it as Alt+A in 3D MAX software, and an alignment tool can be used.



You may set multiple sets of keyboard shortcuts here. When you press the button on the pen, all the shortcuts functions you set will run again.

The functions displayed in red box will be different upon different devices.

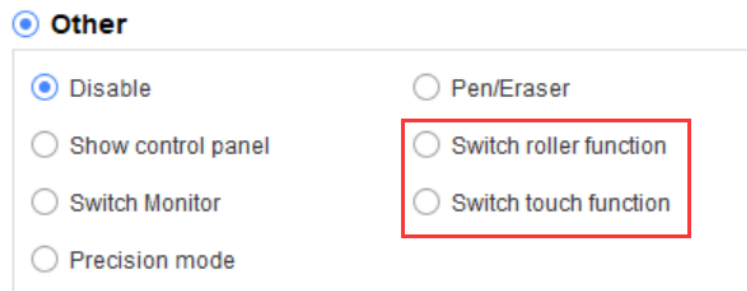

Precision mode:

Precision mode is to limit the work area of the device to a small area. This function may allow you to make more detailed drawings for some areas.

Pressure adjustment:

The sensitivity of pressure may be adjusted by adjusting the "output" and "pen pressure" curves or moving the slider on the progress bar.

Current pressure can test your current pen pressure.

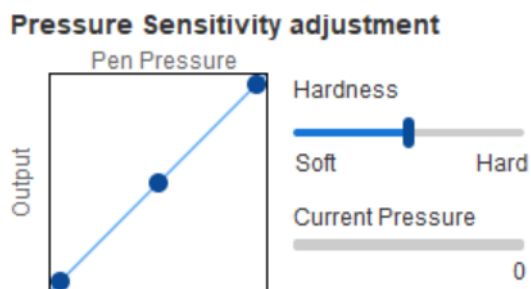

Mouse mode:

The mouse uses the absolute mode by default. Check this to use the relative mode. After selecting it, you can adjust the speed of the cursor.

Absolute coordinate (pen mode): This is the standard mode. Absolute coordinate is to scale down the display area of your screen to the work area of the pen display.

Relative coordinate (mouse mode): The operation method of this mode is the same as that of a normal mouse.



Windows Ink:

Some drawing software can support Windows Ink pen pressure, and you can select or cancel "Windows Ink" to open or close this function, which is opened by default.

2.7 Shortcut keys

To use the shortcut keys of the device, set the input method to English mode. Setting to another mode may not function correctly.

The shortcut key of the device is the command key of Photoshop as the default value. You can customize shortcut keys according to your personal needs, different devices have different numbers of shortcut keys.

If the device has a roller or a touch, it is recommended that you set one of the shortcut keys to "Switch Ring function"(if applicable), so that to switch roller or touch control function.

Customize shortcut keys:

Select "customize" from the drop-down menu to customize the function of each shortcut key. The setting steps are the same as those of pen keys (see 2.6 Pen settings).

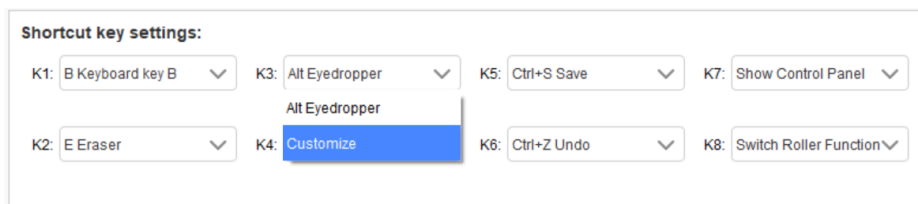

2.8 Touch/Roller

2.8.1 Roller 1

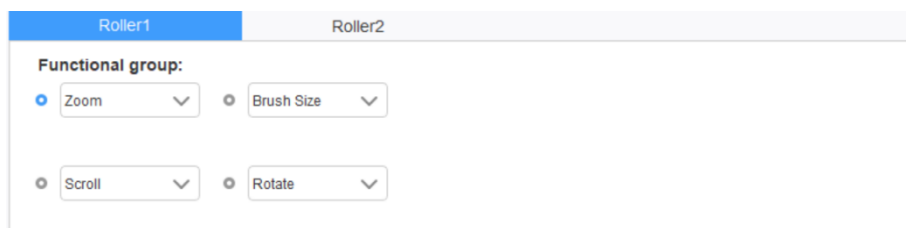

Select the function you want to use from the default four groups of functions. You can customize or set this function invalid.

Customize:

In the custom settings, you can set KL and KR to corresponding key combinations and custom name them.

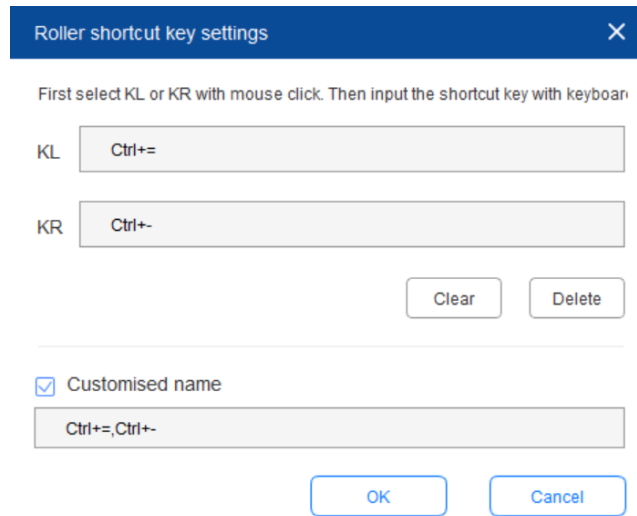

2.8.2 Roller 2

The setting procedure is the same as that of the Roller 1.

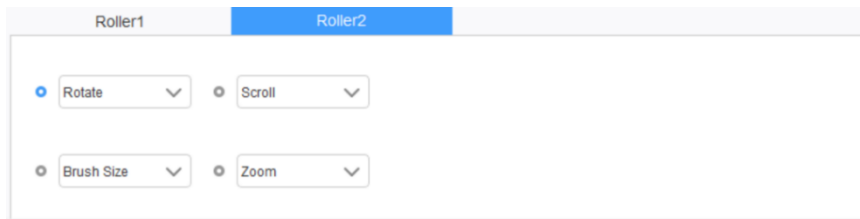

2.9 Settings

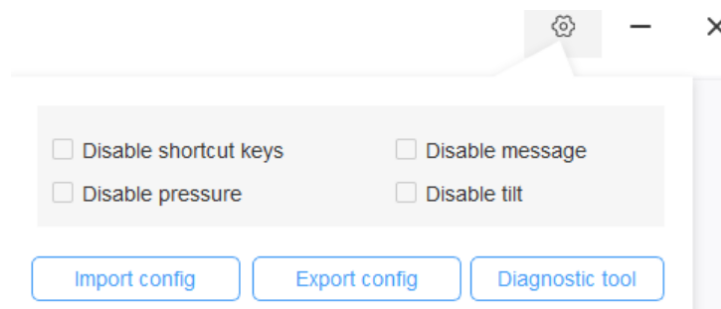

Disable shortcut keys:

Close functions of all shortcut keys.

Disable message:

When the shortcut key is used, no message will be displayed at the bottom of the screen when this function is checked.

Disable pressure:

You will not feel the pressure of the stylus when using this stylus.

Disable tilt:

Disable the tilt function of the stylus.

Diagnostic tool:

If there is any problem while using the driver, you can use a diagnostic tool.

Import & export config:

You can import and export the configured shortcut keys and other functions to store and read their settings.

Notes:

When you need to import & export the changed functions, please click the "OK" button on the left side of the driver interface first to save the configuration.

If you need any further assistance, please contact us at:

Website: www.xp-pen.com

Email: service@xp-pen.com